







Legend: A  Service Chest
 Columns
 Fire Hydrants/extinguishers

 Main passageway

 No rigging zone
 Smoke curtain h = 7,90 m.
 Using pre-rigging; H o-ring 7,40 m.

Note: The location of pre-rigging zones are estimates





STAND:
5A201

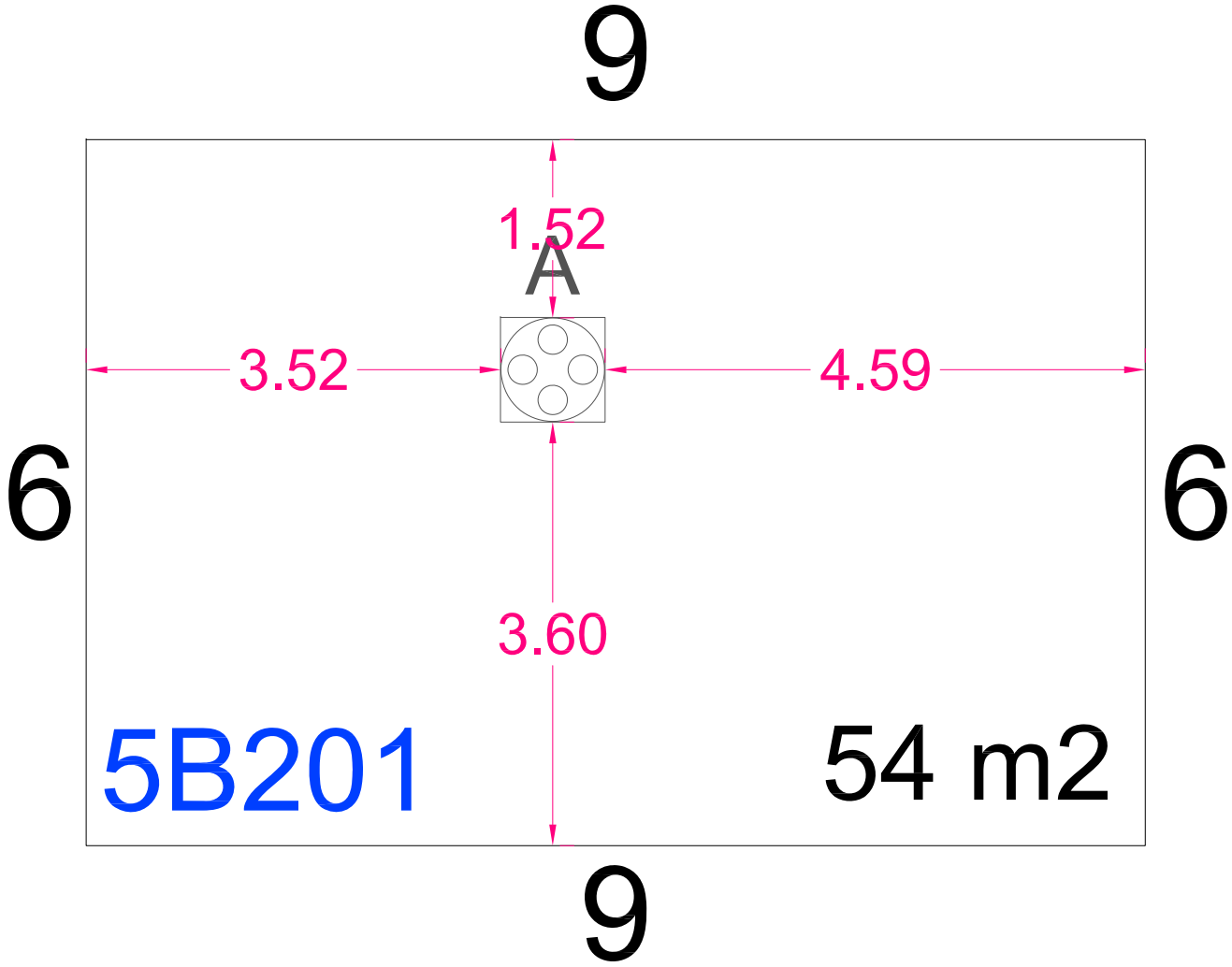





Stand plan



Legend:

-  Service chest 90x90cm
-  Fire hose
-  Fire extinguisher

Maximum Height

-  6m
-  5m (Under walkway projection + 25cm)
-  4.58m
-  4.55m
-  4m
-  2.5m

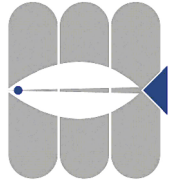
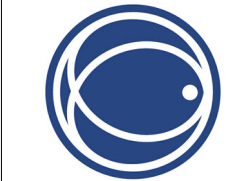

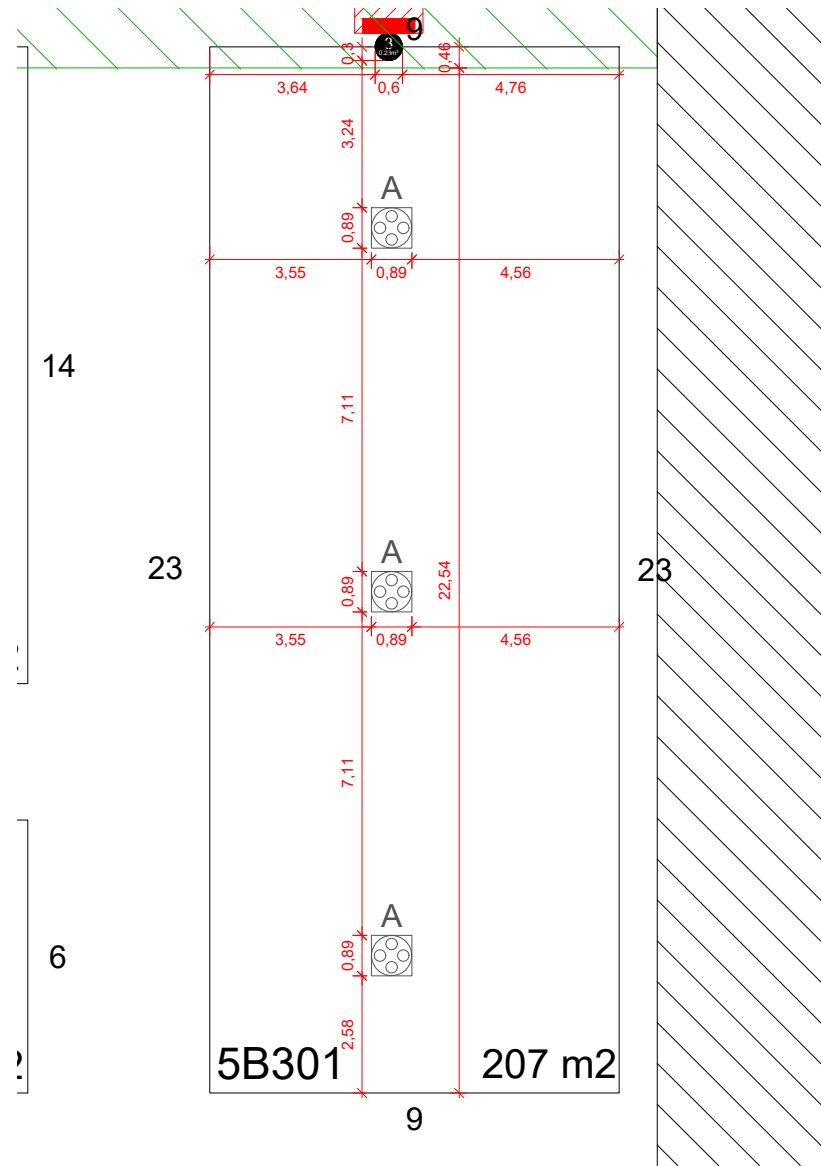

Legend:

- Service Chest
- Columns
- Fire Hydrants/extinguishers

Main passageway

Using 14.00 m pre-rigging; H rigging 6.50 m.

Using pre-rigging; H o-ring 7.40 m.

No-rigging zones.

Note: The location of pre-rigging zones are estimates



STAND:
5B301

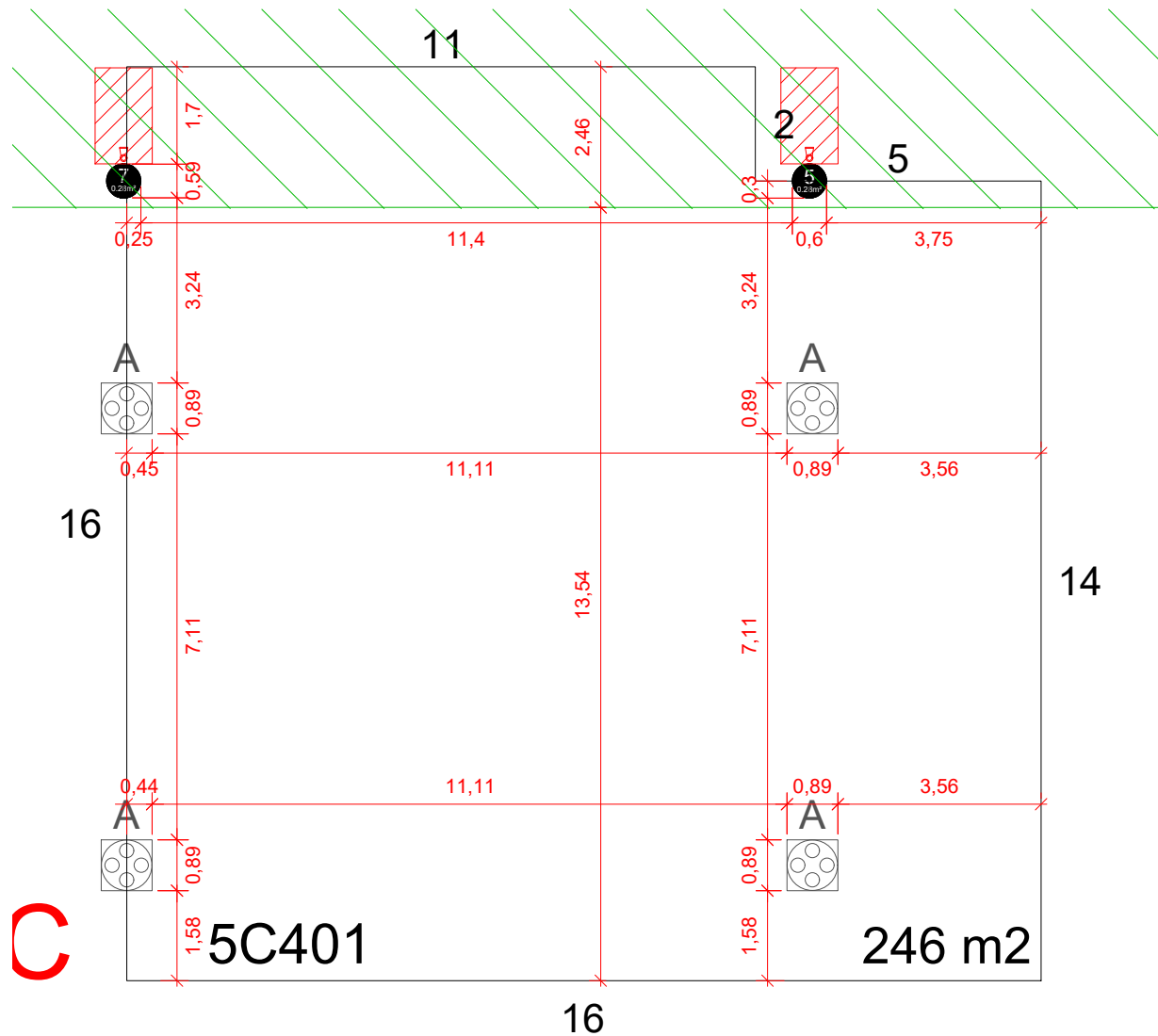

Legend:

- Service Chest
- Columns
- Fire Hydrants/extinguishers

Main passageway

- Using 14.00 m pre-rigging; H rigging 6.50 m.
- Smoke curtain h = 7.90 m.
- Using pre-rigging; H o-ring 7.40 m.

No-rigging zones.

Note: The location of pre-rigging zones are estimates



STAND:
5C401